



KALORA
HEART OF THE HOME



2024 Product Brochure



kalora

HEART OF THE HOME

Our mission at Kalora is to bring heating back to the realms of affordability with a high quality product that is designed to fit as comfortably in the contemporary stylings of a modern environment as it is in a traditional country homestead.

The team at Kalora have extensive experience designing, manufacturing and supplying quality heating appliances to Australian's for over 70 years. The Kalora range is the result of a collaborative effort to produce one of the most efficient, environmentally friendly heating ranges ever to be sold in the Australian market.

Designed and manufactured in our state of the art, world class facility each Kalora appliance is constructed and finished in the highest quality materials available. We combine high tech industrial design, robotic technology and quality materials to ensure years of "hassle free heating" with the backing of a 15 year firebox warranty on selected Kalora appliances.



designed

AND BUILT TO LAST

- ✔ Kalora's range of radiant and fan forced convection wood fires are engineered to efficiently heat homes up to 300m².
- ✔ All Kalora wood fired appliances meet or exceed the 2019 Australian Standards for emissions and efficiency.

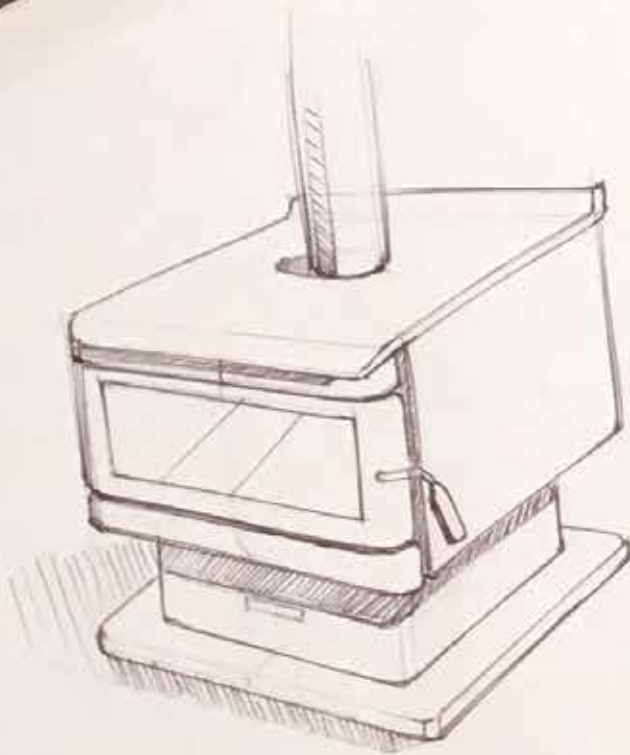

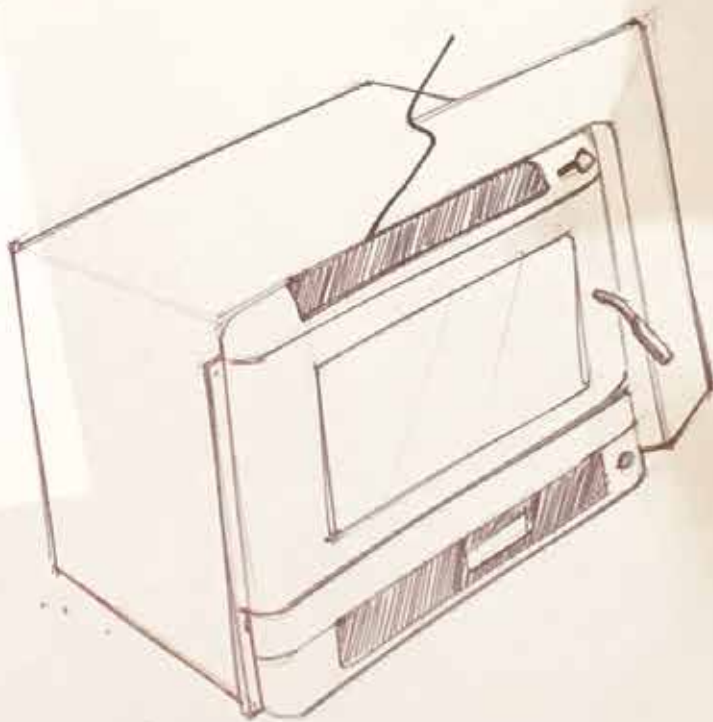
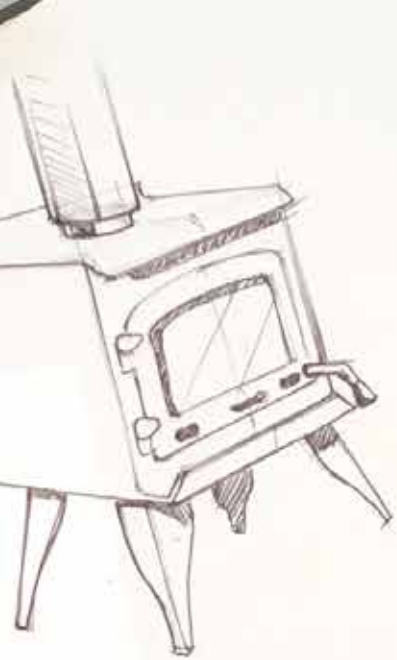

- ✔ Premium quality Senotherm high temperature paint is the standard finish on all Kalora appliances.
- ✔ High alumina silica firebricks included in our wood fired appliances improve efficiency, reduce emissions and maximise the life of the firebox.
- ✔ Kalora wood fired appliances are designed to maximise burn times and fulfill our obligations to reduce emissions under the Australian Standard.
- ✔ Don't have a chimney? Not a problem, Zero clearance solutions are available for all Kalora inbuilt wood & gas fired appliances.
- ✔ Kalora appliances include high quality, low maintenance fireproof glass that is made in Japan.
- ✔ Our "clearview" air wash system keeps the fireproof glass clear and cleaner, for longer.



striving towards

A SUSTAINABLE FUTURE

KALORA IS COMMITTED TO ENVIRONMENT SUSTAINABILITY AND PROMOTES THE USE OF RENEWABLE ENERGY.

We support good forestry practices and ongoing improvements in wood burning stoves and heaters that use firewood. Firewood serves an important role in Australia's domestic heating sector and is an affordable heating option for many families.

As a renewable fuel source sustainability sourced firewood does not add to a net greenhouse gas production; in fact International pressure to reduce greenhouse gas emissions are highlighting wood fired appliances as a key contributor to them achieving their emission targets.

When sustainably managed, firewood recycles carbon from the atmosphere. Firewood plantations can also serve other ecologically desirable functions including wastewater treatment, salination reduction, erosion control, wildlife habitat and aesthetics.

Using firewood to heat your home is the most sustainable form of heating and far more efficient and environmentally friendly alternative to electric heating which relies on base load power generated by coal fueled power stations.





425R

Beautifully crafted compact and affordable without compromising on performance and efficiency.

Small in size, the Kalora 425R is the perfect investment for a cottage, holiday house or man cave.

THE BENEFITS

- 1 SMALL BUT MIGHTY**
Ideal heating solution for a cottage, mancave or holiday house
- 2 DUAL AIR CONTROLS**
Achieve a better, more efficient burn with dual air controls*
- 3 KEEPING IT TRADITIONAL**
Cast Iron door and stylish features enables the 425R to create a cosy ambiance like no other.

TECHNICAL SPECIFICATIONS

- Heat up to 140m²
- Firebox: 440w x 330d x 428h
- Efficiency 63%
- Radiant heating - no fan
- Heater: 500w x 470d x 735h
- Emissions 1.5g/kg
- 5mm heavy duty firebox
- Radiant cooking surface
- kW Rating 15.6kW
- Fifteen year firebox warranty
- Log size to 300mm

WHAT YOU WILL NEED

FLUE KIT OPTIONS

- Default matte black flue kit SG010400034
- Default black mesh flue kit FFK64M2

ROOF FLASHING OPTIONS

- Metal Roof Flashing FF036
- Tile Roof Flashing FF037

CONSUMABLE ITEMS

- Firebrick Set SP14008
- Baffle SP14017
- Brick Retainer SP14007
- Glass Retainer SP14015
- Rope Seal SG030300004

HEARTH OPTIONS: Straight 1050mm x 1200mm Corner 1250mm x 1250mm

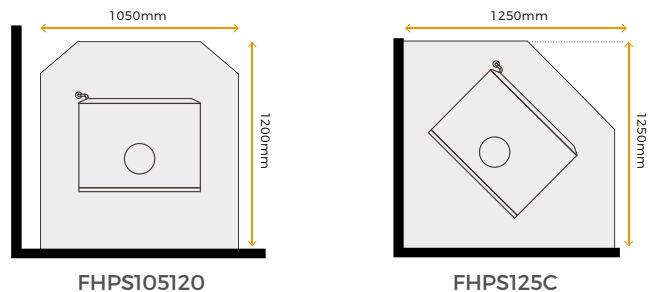

Please note: All wood heaters must be installed by a qualified person whose work conforms with local council regulations, Australian/New Zealand standards (AS/NZS 2918:2018) & manufacturers recommendations.

MUST HAVES

Complete your setup with a comprehensive range of Forge-designed fireside accessories, cleaning, and maintenance products.



Forge Urban XL Wood Storage

Forge Mahogany Fire Tool Set

Forge Dry Glass Cleaner

Forge Exo Fan

*When operated correctly as per user manual



Chalet 5









Introducing our revolutionary Chalet range of wood fires— the epitome of affordability and functionality. Unleash the warmth of high-end features without breaking the bank.

Elevate your home with a stylish, cost-effective heating solution that embodies both comfort and sophistication.

THE BENEFITS

- 1 MODERN TAKE ON A CLASSIC**
Sharp lines, flat finish, and square shape bring a contemporary edge to the timeless comfort it provides.
- 2 PEACE OF MIND**
Know that we back our products: with Kalora Chalet you'll get a 10 firebox warranty.
- 3 IMPROVED COMFORT**
Heat up rooms quickly and maintain a comfortable temperature with convection fan forced heating.

TECHNICAL SPECIFICATIONS

-  Heat up to 200m²
-  Firebox: 500w x 360d x 300h
-  Efficiency 67%
-  Convection heating - fan forced
-  Heater: 595w x 509d x 724h
-  Emissions 1.1g/kg
-  5.5mm heavy duty firebox
-  Log size to 300mm
-  kW Rating 7.9kW
- 10** Ten year firebox warranty

WHAT YOU WILL NEED

FLUE KIT OPTIONS

- Default matte black flue kit SG010400034
- Default black mesh flue kit FFK64M2

ROOF FLASHING OPTIONS

- Metal Roof Flashing FF036
- Tile Roof Flashing FF037

Please note: All wood heaters must be installed by a qualified person whose work conforms with local council regulations, Australian/New Zealand standards (AS/NZS 2918:2018) & manufacturers recommendations.

HEARTH OPTIONS: Straight 1050mm x 1200mm Corner 1250mm x 1250mm

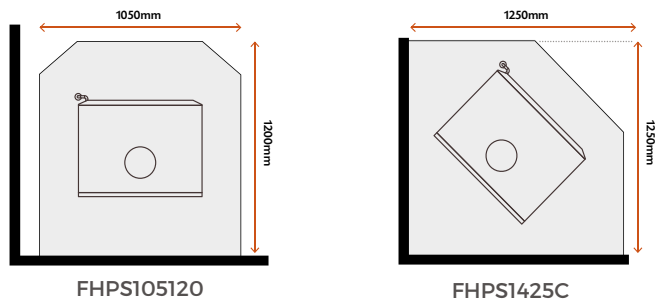

MUST HAVES

Complete your setup with a comprehensive range of Forge-designed fireside accessories, cleaning, and maintenance products.



Forge Hexagon 850 Corten Wood Storage

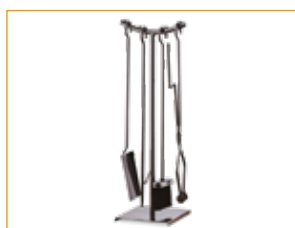

Forge Iron Grey Fire Tool Set



Senotherm Metallic Black Paint



Forge Corner Heater Guard



Chalet 6











Introducing our revolutionary Chalet range of wood fires—an epitome of affordability and functionality. Unleash the warmth of high-end features without breaking the bank.

Elevate your home with a stylish, cost-effective heating solution that embodies both comfort and sophistication.

THE BENEFITS

- 1** **GENEROUS CAPACITY**
Experience ample space for larger logs, allowing for longer burning times and fewer reloads.
- 2** **AFFORDABLE QUALITY**
Enjoy the warmth of quality wood fires without straining your budget.
- 3** **ONE FOR THE ENVIRONMENT**
Efficiently heating large areas reduces energy use and environmental impact.

TECHNICAL SPECIFICATIONS

-  Heat up to 300m²
-  Firebox: 600w x 400d x 360h
-  Efficiency 62%
-  Convection heating - fan forced
-  Heater: 695w x 569d x 767h
-  Emissions 1.3g/kg
-  5.5mm heavy duty firebox
-  Log size to 350mm
-  kW Rating 10.1kW
-  **10** Ten year firebox warranty

WHAT YOU WILL NEED

FLUE KIT OPTIONS

- Default matte black flue kit SG010400034
- Default black mesh flue kit FFK64M2

ROOF FLASHING OPTIONS

- Metal Roof Flashing FF036
- Tile Roof Flashing FF037

Please note: All wood heaters must be installed by a qualified person whose work conforms with local council regulations, Australian/New Zealand standards (AS/NZS 2918:2018) & manufacturers recommendations.

HEARTH OPTIONS: Straight 1050mm x 1200mm Corner 1425mm x 1425mm

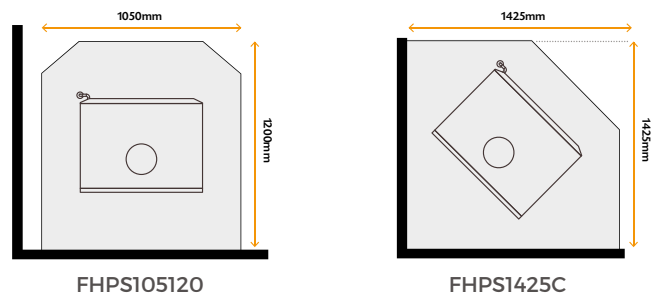

MUST HAVES

Complete your setup with a comprehensive range of Forge-designed fireside accessories, cleaning, and maintenance products.



Forge Hexagon 850 Corten Wood Storage



Forge Iron Grey Fire Tool Set



Senotherm Metallic Black Paint

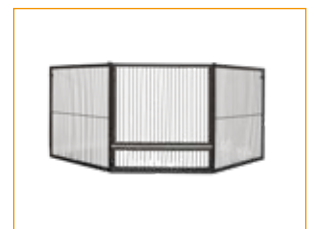

Forge Corner Heater Guard



500C

Create an irresistible atmosphere of beauty and warmth with this beautifully crafted fireplace.

The fan forced convection heating allows minimal clearance requirements which makes it a great choice for homes where space and proximity to combustible items presents a challenge.

THE BENEFITS

- 1 WE'VE GOT YOU COVERED**
15 year firebox warranty means quality you can trust
- 2 IT'S IN THE DETAILS**
Stunning oak finishes, stainless steel highlights and classical design make this wood fire a point of discussion in any room.
- 3 MINIMAL CLEARANCES**
This is the perfect solution for any home where space and proximity to combustible items present a challenge.

TECHNICAL SPECIFICATIONS

- Heat up to 200m²
- Convection heating - fan forced
- 5.5mm heavy duty firebox
- Fifteen year firebox warranty
- Firebox: 500w x 330d x 397h
- Heater: 672w x 490d x 720h
- Log size to 300mm
- Efficiency 67%
- Emissions 1.1g/kg
- kW Rating 7.9kW

WHAT YOU WILL NEED

FLUE KIT OPTIONS

- Default matte black flue kit SG010400034
- Default black mesh flue kit FFK64M2

ROOF FLASHING OPTIONS

- Metal Roof Flashing FF036
- Tile Roof Flashing FF037

CONSUMABLE ITEMS

- Firebrick Set SP20009
- Baffle SP20033
- Brick Retainer SP20035
- Glass Retainer SP20017
- Rope Seal SG030300006

HEARTH OPTIONS: Straight 1050mm x 1200mm Corner 1250mm x 1250mm

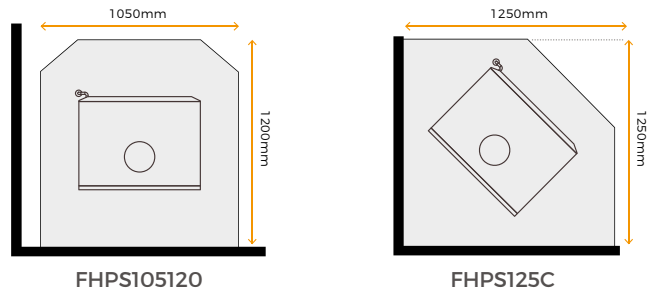

Please note: All wood heaters must be installed by a qualified person whose work conforms with local council regulations, Australian/New Zealand standards (AS/NZS 2918:2018) & manufacturers recommendations.

MUST HAVES

Complete your setup with a comprehensive range of Forge-designed fireside accessories, cleaning, and maintenance products.



Forge 500 Hexagon Wood Storage



Forge Ellipse Fire Tool Set



Forge Gloves

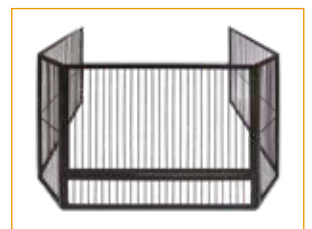

Forge Large Safety Guard



600C

Love the romance of an open fire and the cosy warmth of an efficient slow combustion wood heater? We found your match.

The largest wood fire in the Kalora range, the 600C is a powerhouse with a fan assisted convection capable of heating homes and large open plan spaces.

THE BENEFITS

- 1 MAXIMISED BURN TIMES**
Keep your home warmer for longer with a large 600w x 400d firebox
- 2 ROBUST CONSTRUCTION**
Built to withstand the rigors of regular use, providing long-lasting durability and reliability.
- 3 CUSTOMISE YOUR COMFORT**
3 adjustable fan speeds enables you to control the intensity of the warmth.

TECHNICAL SPECIFICATIONS

- Heat up to 300m²
- Firebox: 600w x 400d x 430h
- Efficiency 62%
- Convection heating - fan forced
- Heater: 772w x 565d x 792h
- Emissions 1.3g/kg
- 5.5mm heavy duty firebox
- Log size to 350mm
- kW Rating 10.1kW
- 15** Fifteen year firebox warranty

WHAT YOU WILL NEED

FLUE KIT OPTIONS

- Default matte black flue kit SG010400034
- Default black mesh flue kit FFK64M2

ROOF FLASHING OPTIONS

- Metal Roof Flashing FF036
- Tile Roof Flashing FF037

CONSUMABLE ITEMS

- Firebrick Set SP30010
- Baffle SP30033
- Brick Retainer SP30035
- Glass Retainer SP30017
- Rope Seal SG030300006

HEARTH OPTIONS: Straight 1050mm x 1200mm Corner 1425mm x 1425mm

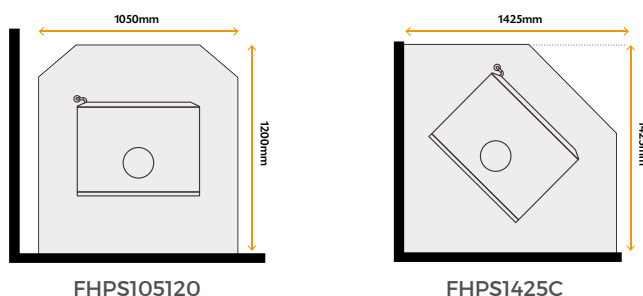

Please note: All wood heaters must be installed by a qualified person whose work conforms with local council regulations, Australian/New Zealand standards (AS/NZS 2918:2018) & manufacturers recommendations.

MUST HAVES

Complete your setup with a comprehensive range of Forge-designed fireside accessories, cleaning, and maintenance products.



Forge Oblique Wood Storage



Forge Ellipse Fire Tool Set



Forge Easy Soot Remover



Forge 6" Flue Brush



500BX











Say goodbye to the winter blues this year and look forward to toasty nights by the fire with your loved ones.

Get the amazing performance and quality you expect from a Kalora 500 with the added advantage of a wood storage pedestal, ideal for this nights when it is just too cold to go outside for more wood.

THE BENEFITS

- 1 KEEPING YOU WARM**
Easily heat up to 200m² with the generously sized 500BX
- 2 NEAT AND TIDY**
No need to worry about extra wood storage when you've got the woodbox pedestal included.
- 3 QUALITY GUARENTEED**
5.5mm heavy duty firebox with a 15 year warranty* and 8mm heavy duty steel baffle plate.

TECHNICAL SPECIFICATIONS

-  Heat up to 200m²
-  Firebox: 500w x 330d x 397h
-  Efficiency 67%
-  Convection heating - fan forced
-  Heater: 672w x 490d x 852h
-  Emissions 1.1g/kg
-  5.5mm heavy duty firebox
-  In-built wood storage
-  kW Rating 7.9kW
-  Fifteen year firebox warranty
-  Log size to 300mm

WHAT YOU WILL NEED

FLUE KIT OPTIONS

- Default matte black flue kit SG010400034
- Default black mesh flue kit FFK64M2

ROOF FLASHING OPTIONS

- Metal Roof Flashing FF036
- Tile Roof Flashing FF037

CONSUMABLE ITEMS

- Firebrick Set SP20009
- Baffle SP20033
- Brick Retainer SP20035
- Glass Retainer SP20017
- Rope Seal SG030300006

HEARTH OPTIONS: Straight 1050mm x 1200mm Corner 1250mm x 1250mm

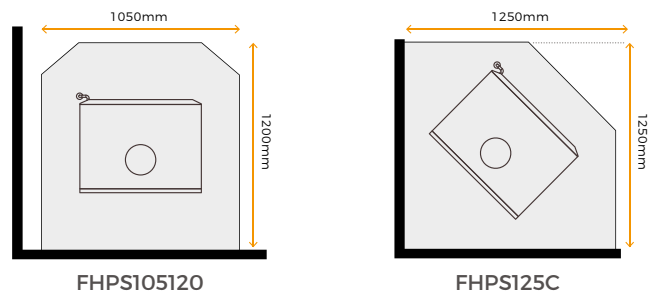

Please note: All wood heaters must be installed by a qualified person whose work conforms with local council regulations, Australian/New Zealand standards (AS/NZS 2918:2018) & manufacturers recommendations.

MUST HAVES

Complete your setup with a comprehensive range of Forge-designed fireside accessories, cleaning, and maintenance products.



Forge Zero 1000 Wood Storage



Forge Valyrian Fire Tool Set



Forge Moisture Meter



Forge Rope Seal Kit

*Warranty is covered as stated in manual and is subject to warranty criteria.



600BX

Love the romance of an open fire and the cosy warmth of an efficient slow combustion wood heater? We found your match.

The largest wood fire in the Kalora range, the 600C is a powerhouse with a fan assisted convection capable of heating homes and large open plan spaces.

THE BENEFITS

- 1 BIG HEAT WHERE YOU NEED IT**
600BX is the largest of the Kalora range, boasting a huge 600w x 400d firebox.
- 2 MINIMALIST DESIGN**
No need for additional wood storage - the 600BX has one built in.
- 3 ENHANCED EFFICIENCY**
The 600BX boasts an average efficiency of 62%, ensuring that you get the most out of every wood burn.

TECHNICAL SPECIFICATIONS

- Heat up to 300m²
- Firebox: 600w x 400d x 430h
- Efficiency 62%
- Convection heating - fan forced
- Heater: 772w x 565d x 890h
- Emissions 1.3g/kg
- 5.5mm heavy duty firebox
- In-built wood storage
- kW Rating 10.1kW
- Fifteen year firebox warranty
- Log size to 350mm

WHAT YOU WILL NEED

FLUE KIT OPTIONS

- Default matte black flue kit SG010400034
- Default black mesh flue kit FFK64M2

ROOF FLASHING OPTIONS

- Metal Roof Flashing FF036
- Tile Roof Flashing FF037

CONSUMABLE ITEMS

- Firebrick Set SP30010
- Baffle SP30033
- Brick Retainer SP30035
- Glass Retainer SP30017
- Rope Seal SG030300006

HEARTH OPTIONS: Straight 1050mm x 1200mm Corner 1425mm x 1425mm

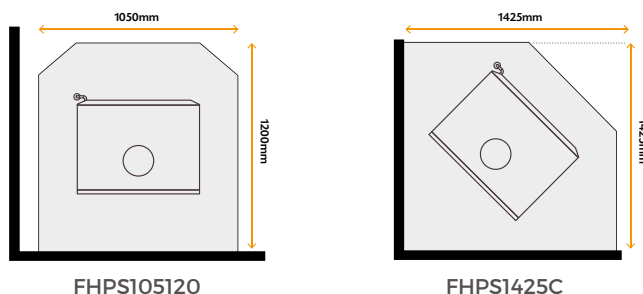

Please note: All wood heaters must be installed by a qualified person whose work conforms with local council regulations, Australian/New Zealand standards (AS/NZS 2918:2018) & manufacturers recommendations.

MUST HAVES

Complete your setup with a comprehensive range of Forge-designed fireside accessories, cleaning, and maintenance products.



Forge Hexagon 850 Corten Wood Storage



Forge Iron Grey Fire Tool Set



Senotherm Metallic Black Paint

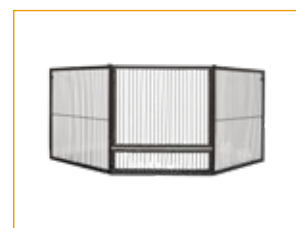

Forge Corner Heater Guard













Fusion

Traditional living at it's finest. Fusion is the result of the synergy that can be achieved when you combine the features of a modern high performance wood heater with the nostalgic feel and benefits of a traditional wood fired stove.

THE BENEFITS

- 1 TEMPERATURE CONTROLLED OVEN**
Manage cooking effortlessly with the temperature-controlled, spacious baking oven.
- 2 DURABLE CONSTRUCTION**
Built to last and crafted with heavy-duty steel components providing reliable performance for years to come.
- 3 VERSATILE HEATING**
With the capability to heat up to 200m², The Fusion ensures warmth spreads efficiently throughout your living space.

TECHNICAL SPECIFICATIONS

-  Heat up to 200m²
-  Firebox: 420w x 340d x 380h
-  **15** Fifteen year firebox warranty
-  Radiant heating - no fan
-  Heater: 650w x 600d x 861h
-  Log size to 300mm
-  5mm heavy duty firebox
-  Oven: 440w x 350d x 230h
-  Optional hot water jacket
-  Radiant cooking surface
-  Large baker's oven

WHAT YOU WILL NEED

FLUE KIT OPTIONS

Default matte black flue kit	SG010400034
Default black mesh flue kit	FFK64M2

ROOF FLASHING OPTIONS

Metal Roof Flashing	FF036
Tile Roof Flashing	FF037

CONSUMABLE ITEMS

Firebox liner (Left)	SP50116	Firebricks	SP50135
Firebox liner (Right)	SP50115	Brick retainer	SP50127
Firebox Bottom Plate	SP50130	Temperature Gauge	SP50109
Glass Retainer Firebox Door	SG030700631	Hot Plates	SP0121
Glass Retainer Oven Door	SG030700632		
Rope Seal	SG030300004		

HEARTH OPTIONS: Straight 1050mm x 1050mm Corner 1250mm x 1250mm

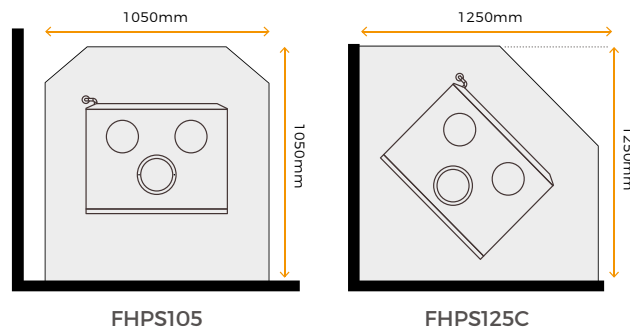

Please note: All wood heaters must be installed by a qualified person whose work conforms with local council regulations, Australian/New Zealand standards (AS/NZS 2918:2018) & manufacturers recommendations.

MUST HAVES

Complete your setup with a comprehensive range of Forge-designed fireside accessories, cleaning, and maintenance products.



Forge Hinterland Wood Storage



Forge Valyrian Fire Tool Set



Forge Moisture Meter



Forge Exo Fan



Urban PT depicted with optional woodbox base

Urban PT

Bring luxury to any size home with the Kalora Urban PT, a unique upright wood fire meticulously designed and engineered in Australia for our unique conditions.

With the Urban PT's eye-catching aesthetics, user-centric features, and innovative interchangeable base system you'll enjoy clean, low-emission combustion and contemporary styling that defines modern elegance.

THE BENEFITS

- 1 SLIMLINE DESIGN**
The stylish upright configuration ensures the Urban PT can effortlessly blend into any space.
- 2 IMPRESSIVELY EFFICIENT**
The Urban PT boasts emissions of less than half the standard, ensuring a cleaner, greener choice for you and the world.
- 3 ELEVATE THE LOOK**
Choose to mount the Urban PT on the Plinth with 3 different placing options or create the minimalist dream with the woodbox instead.

TECHNICAL SPECIFICATIONS

- Heat up to 200m²
- Optional 3 Speed wireless fan control
- 5mm heavy duty firebox
- 15** Fifteen year firebox warranty
- Firebox: 365w x 320d x 500h
- Heater: 518w x 586d x 720h
- Log size to 300mm
- Efficiency 68%
- Emissions 0.5g/kg
- kW Rating 7.3kW

WHAT YOU WILL NEED

FLUE KIT OPTIONS

- Default matte black flue kit SG010400034
- Default black mesh flue kit FFK64M2

ROOF FLASHING OPTIONS

- Metal Roof Flashing FF036
- Tile Roof Flashing FF037

Please note: All wood heaters must be installed by a qualified person whose work conforms with local council regulations, Australian/New Zealand standards (AS/NZS 2918:2018) & manufacturers recommendations.

HEARTH OPTIONS: Straight 1050mm x 1200mm Corner 1250mm x 1250mm

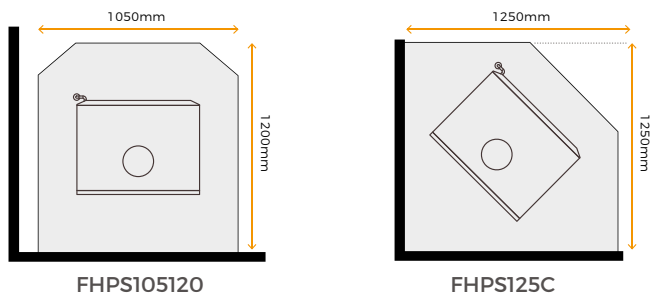

DESIGN OPTIONS



URBAN PT DEPICTED WITH OPTIONAL PLINTH



Urban LS depicted with optional woodbox base

Urban LS











Immerse yourself in fireside luxury with the Kalora Urban LS wood fire, meticulously designed and engineered in Australia for our unique conditions.

Elevate your home with the innovative eye-catching aesthetics and user-centric features. Enjoy clean, low-emission combustion and contemporary styling that defines modern elegance.

THE BENEFITS

- 1 HEAT PROJECTION**
Vermiculite liners will give you a more efficient, cleaner burn, projecting heat into the room.
- 2 YOUR FIRE, YOUR WAY**
Choose from 4 base options: Plinth, woodbox, pedestal or create your own custom concrete plinth.
- 3 WARMER FOR LONGER**
This massive firebox gives you the ability to have your fire burning for an impressive 12 - 14 hours*.

TECHNICAL SPECIFICATIONS

-  Heat up to 250m²
-  Firebox: 795w x 317d x 328h
-  Efficiency 61%
-  optional 3 Speed wireless fan control
-  Heater: 950w x 586d x 504h
-  Emissions 0.7g/kg
-  5mm heavy duty firebox
-  Log size to 350mm
-  kW Rating 9.0kW
-  **15** Fifteen year firebox warranty

WHAT YOU WILL NEED

FLUE KIT OPTIONS

- Default matte black flue kit SG010400034
- Default black mesh flue kit FFK64M2

ROOF FLASHING OPTIONS

- Metal Roof Flashing FF036
- Tile Roof Flashing FF037

Please note: All wood heaters must be installed by a qualified person whose work conforms with local council regulations, Australian/New Zealand standards (AS/NZS 2918:2018) & manufacturers recommendations.

HEARTH OPTIONS: Straight 1200mm x 1200mm

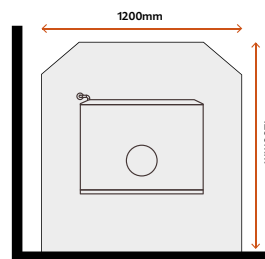

DESIGN OPTIONS



URBAN LS DEPICTED WITH OPTIONAL PEDESTAL



URBAN LS DEPICTED WITH OPTIONAL PLINTH



*Low burn time estimates based on user following instruction manual.



Accent











The Kalora Accent inbuilt wood heater has been specifically designed for installation into existing masonry fireplaces overcoming the inefficiencies associated with traditional open fires such as excessive fuel burn, uncontrollable heat levels and energy that is lost straight out of the chimney.

The Accent also accommodates for those who love the look of an inbuilt wood heater but do not have an existing open fireplace. Our zero clearance solutions avail the opportunity to install the Kalora Accent into a timber-framed wall with the need for only minimal clearances.

THE BENEFITS

- 1 PERFECT FOR THE PRE-EXISTING**
Designed to fit into existing masonry fireplaces to overcome inefficiencies giving you more control.
- 2 ZERO CLEARANCE OPTION**
Allows you to install the Accent into a timber-framed wall with minimal clearances.
- 3 MINIMALIST DESIGN**
Clean lines and minimalist features, paired with gentle touch controls, allow the flame to be the focal point of the room.

TECHNICAL SPECIFICATIONS

-  Heat up to 280m²
-  Firebox: 600w x 480d x 354h
-  Efficiency 61%
-  To suit mid or floor mount install
-  Heater: 672w x 480d x 592h
-  Emissions 1.4g/kg
-  Zero clearance option
-  5.5mm heavy duty firebox
-  kW Rating 12.8kW
-  15 Fifteen year firebox warranty
-  Log size to 300mm

WHAT YOU WILL NEED

<p>INBUILT MASONRY CAVITY INSTALL</p> <p>6" 4M Inbuilt Flue Kit SCFK64MINB</p>	<p>INBUILT TIMBER STUD CAVITY INSTALL</p> <p>Zero Clearance Box SG010400052</p> <p>Triple Skin Zero Clearance Flue Kit SCFKZCB06</p>	<p>ROOF FLASHING OPTIONS</p> <p>Metal Roof Flashing FF036</p> <p>Tile Roof Flashing FF037</p>
<p>CONSUMABLE ITEMS</p> <p>Firebrick Set SG030600024</p> <p>Baffle SG030700263</p> <p>Brick Retainer SG030700269</p> <p>Door Assembly SG030700825</p> <p>Rope Seal SG030300005</p>	<p>FASCIA DIMENSIONS</p> <p>Mid-mount 769w x15d x 649h</p> <p>Floor-mount 769w x 15d x 629h</p>	<p>HEARTH OPTIONS :</p> <p>Matt Black Inbuilt Hearth Pad SG040100015</p> <p>1050w x 550d x 30h</p>

Please note: All wood heaters must be installed by a qualified person whose work conforms with local council regulations, Australian/New Zealand standards (AS/NZS 2918:2018) & manufacturers recommendations.



MUST HAVES

Complete your setup with a comprehensive range of Forge-designed fireside accessories, cleaning, and maintenance products.

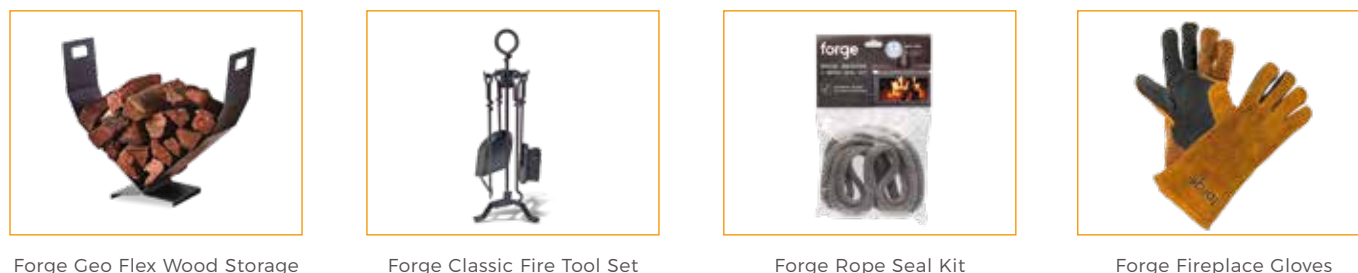

Forge Geo Flex Wood Storage

Forge Classic Fire Tool Set

Forge Rope Seal Kit

Forge Fireplace Gloves



Sorrento

Enhance your home with a beautifully crafted, elegant Kalora Sorrento.













Inspired by winter's spent on the Mornington Peninsula, Sorrento embodies the "heart of the home" philosophy with beach side themed flame media encased in an expansive firebox lined with high gloss reflective panels, a glass primary shield and framed in your choice of a beautiful black or (optional) stunning stainless one piece fascia.

Engineered to a precise specification this space heating appliance comes with a fully programmable remote control, is 4 star rated and offers four alternative burn media options.

THE BENEFITS

- 1 ENJOY THE CONVENIENCE**
With just the press of a button you can easily ignite, control and program the flames.
- 2 CHOOSE YOUR MEDIA**
Customise the media inside the Sorrento to suit your home, style and design
- 3 ENHANCED AIR CIRCULATION**
The dual multi-speed fans ensure efficient distribution of heat, maximizing comfort and even heating.

TECHNICAL SPECIFICATIONS

- | | | |
|---|--|--|
|  Heat up to 90m ² |  Black & stainless fascia options |  Average efficiency 79% |
|  To suit mid or floor mount install |  4 decorative media options |  Thermostatic control (7 day programming) |
|  Heater: 672w x 480d x 592h |  High gloss reflective firebox liners |  Dual multi speed fans |
|  Gas log fire |  10 Ten year firebox warranty |  Remote control (Included with appliance) |

CHOOSE YOUR FASCIA



Beautiful Black Fascia (included)



Stunning Stainless Fascia (optional)

CHOOSE YOUR MEDIA

With Sorrento's range of options you can create a truly personal statement customised by you and tailored to your own individual taste.



Driftwood, pebbles and glass (Included)



Pebbles and glass



Driftwood, pebbles and coal effect



Pebbles and coal effect



Zenith













Discover the epitome of warmth and style with the Zenith Electric Flame Effect Fireplace from Kalora. Elevate your space with versatile installation options: front mount, 2 side corner mount, or 3-sided mount.

Boasting 1500W heating power, WiFi app control, and customizable flame settings, it's where modern convenience meets Kalora's timeless cosiness.

THE BENEFITS

- 1 3 DIFFERENT MOUNTING OPTIONS**
Choose 1, 2 or all 3 sides of the Zenith exposed for a greater ambient experience by removing the left, right or both side panels.
- 2 WIFI APP CONTROL**
Control anywhere, anytime using the wifi/ app control from your phone or tablet.
- 3 AESTHETIC APPEAL**
The trueFLAME log & coal setting creates a realistic fireplace ambiance, adding warmth and character to your living space.

TECHNICAL SPECIFICATIONS

-  Wifi app control & Remote control
-  3 flame flicker speeds
-  Flame colour adjustment
-  Flame brightness setting
-  750W or 1500W heating capacity
-  Stylish contemporary design
-  Realistic trueFLAME log & coal setting
-  5 sizes to choose from
-  **2** Two year warranty
-  Safety over temperature cut-out
-  **3** installation options (front, 2-side corner or 3-sided mount)
-  Electric flame effect

CHOOSE YOUR SIZE



Zenith 36"



Zenith 42"



Zenith 60"



Zenith 72"



Zenith 88"



Nexus













Transform your space with Kalora's Nexus Electric Flame Effect Fireplace, a fusion of elegance and innovation.

Seamlessly sync with Google and Alexa for smart home control. Choose between 750W or 1500W heating options, creating a cosy haven. Its refined design and versatile installation, whether recessed or wall-mounted, make it an exquisite focal point.

THE BENEFITS

- 1 PERSONALISED AMBIENCE**
With 13 flame and fuel bed color options, you can tailor the ambiance to suit any mood or space.
- 2 SAFETY FIRST**
The cool-to-touch toughened glass feature ensures safety even with extended use.
- 3 PEACE OF MIND**
2-year warranty means your investment is backed by reliable performance and durability.

TECHNICAL SPECIFICATIONS

-  Wifi app control & Remote control
-  13 flame and fuel bed colour options
-  Flame illumination with energy-efficient LED technology
-  750W or 1500W heating options
-  Elegant focal point with balanced proportions
-  Seamlessly integrate with Google and Alexa for smart home control
-  Cool-to-touch toughened glass ensures safety
-  Flexible installation: recessed or wall mounting
-  **2** Two year warranty
-  Overheat protection for added safety
-  Set a timer for 1-9 hours
-  4 sizes to choose from

CHOOSE YOUR SIZE



Nexus 36"



Nexus 50"



Nexus 60"

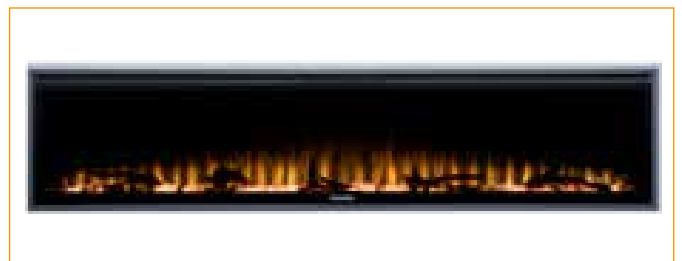

Nexus 74"

Freestanding

Unit Size and Clearances (mm)

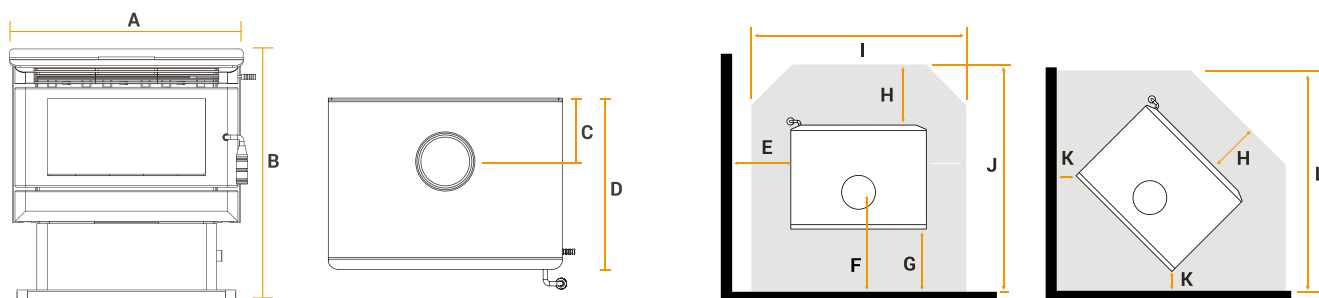

	A	B	C	D	E	F	G	H	I	J	K	L
Kalora 425R	500	735	120	470	625	470	275	350	745	1005	385	1115
Kalora Chalet 5	595	724	173	509	475	298	125	450	900	1075	225	1175
Kalora Chalet 6	695	767	186	569	500	311	125	500	1000	1195	300	1370
Kalora 500C	672	720	197	490	250	347	150	450	900	1070	100	1020
Kalora 600C	772	792	205	560	250	355	150*	300	1000	1000	100	950
Kalora 500BX	672	852	197	490	250	347	150	450	900	1070	100	1020
Kalora 600BX	772	890	205	565	250	355	* 150	300	1000	1000	100	950
Kalora Fusion	650	860	120	609	400	290	170	300	818	994	200	1024
Kalora Urban PT	1097	518	292	586	500	402	150	300	805	740	350	1155
Kalora Urban LS	950	828	295	586	550	555	300	600	1175	1100	n/a	n/a

Inbuilt

Unit Size and Clearances (mm)

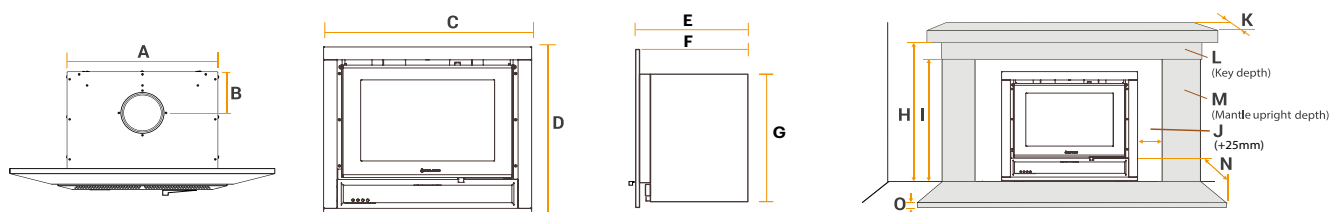

	A	B	C	D	E	F	G	H	I	J	K	L	M	N	O
Kalora Accent	672	167	769	649	495	480	592	1330	1160	70	250	45	45	550	30
Kalora Urban LS	1078	341	1035	592	617	579	562	See user manual for details							
Kalora Urban PT	646	335	605	805	613.56	579	778.5	See user manual for details							
Kalora Sorrento	1235	175	1245	620	450	440	790	See user manual for details							

* When installed with an additional 900mm x 180° stainless steel flue shield between the active flue and decorative mesh casing.

Illustrations and photos reflect typical installations and are for design purposes only. Illustrations/diagrams are not drawn to scale. Actual product may vary from pictures in brochure.

Inbuilt Wood Heaters in a masonry fireplace MUST be fully flued as per recommendations from a qualified installer. Inbuilt Wood Heaters in a timber-frame MUST be installed with a Clearance Box.

Gas space heater

Unit Size and Clearances (mm)

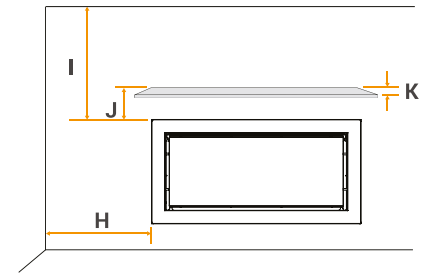
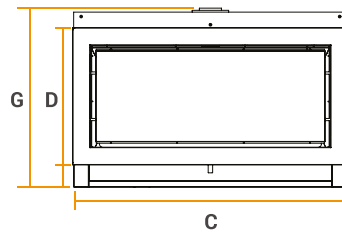
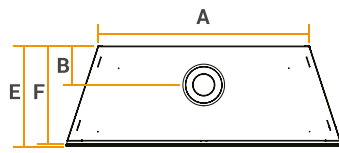

	A	B	C	D	E	F	G	H	I	J	K
Kalora Sorrento	955	175	1234	620	452	440	808	80	1000	360	330

Kalora appliance comparison chart

	Part no	Heating capacity	Emissions	Efficiency	Peak kW rating	Net Weight	Gross weight	Packaged W x D x H
Kalora 425R	KA425R	140m ²	1.5g/kg	63%	15.6kW	95kg	109kg	585 x 585 x 870
Kalora Chalet 5	SG010100019	200m ²	1.1g/kg	67%	7.9kw	118kg	133kg	710 x 610 x 868
Kalora Chalet 6	SG010100020	300m ²	1.3g/kg	62%	10.1kw	148kg	168kg	810 x 675 x 905
Kalora 500C	KA500C	200m ²	1.1g/kg	67%	7.9kW	137kg	156kg	780 x 645 x 880
Kalora 600C	KA600C	300m ²	1.3g/kg	62%	10.1W	175kg	200kg	885 x 710 x 965
Kalora 500BX	KA500BX2	200m ²	1.1g/kg	67%	7.9kW	160kg	179kg	780 x 650 x 1010
Kalora 600BX	KA600BX2	300m ²	1.3g/kg	62%	10.1kW	205kg	220kg	890 x 710 x 1075
Kalora Fusion	KAF50	200m ²	-	-	-	231kg	251kg	770 x 710 x 1070
Kalora Urban PT	SG010100016	200m ²	0.5g/kg	68%	7.3kw	183kg	198kg	633 x 633 x 1152
Kalora Urban LS	SG010100006	250m ²	0.7g/kg	61%	9.0kw	208kg	223kg	1065 x 715 x 895
Kalora Accent	Accent	280m ²	1.4g/kg	61%	12.8kW	133kg	150kg	595 x 850 x 815
Kalora Sorrento	KAGAS10	90m ²	-	79%	-	90kg	110kg	1350 x 585 x 1000

PLEASE NOTE

It is COMPULSORY to have your heater installed by a qualified person whose work conforms to Australian standards, local council regulations and manufacturer's recommendations. Your warranty and any home insurance may be void, on failure to do so.



forge

forge

BY  KALORA



FIRE TOOLS

WOOD STORAGE

HEARTH PADS

MAINTENANCE

CLEANING

FLUE KITS

INSTALLATION ESSENTIALS

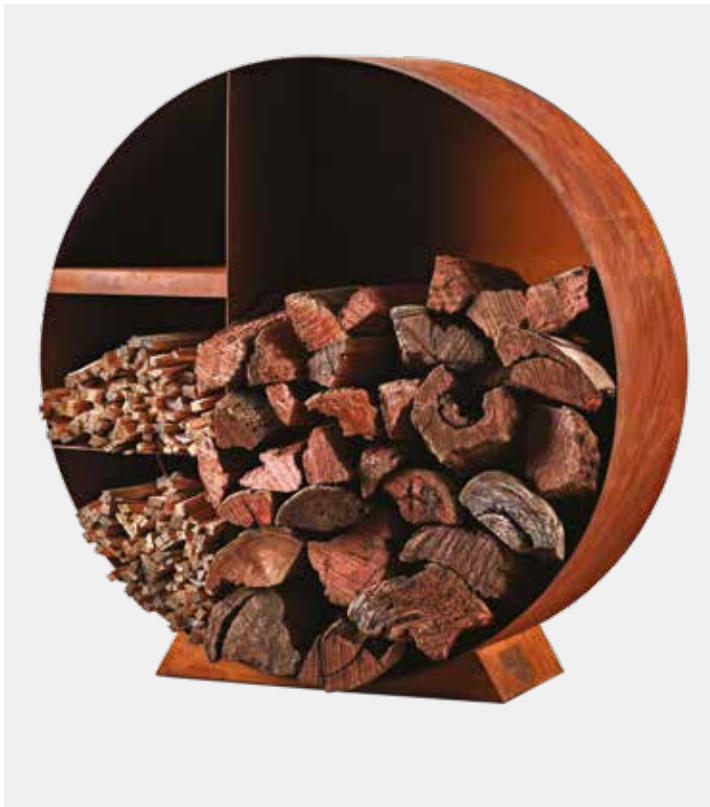

FLS006
Zero 1000 (Corten)
(1000mm in Diameter)



FLS011
Oblique
(500mm W x 700mm H x 300mm D)



FLS008
GeoFlex
(560mm H x 250mm D x 680mm W)



FLS015
Urban Steel XL 1500
(1500mm H x 255mm D x 550mm W)



FLS005
Zero 1000 (Black)
(1000mm in Diameter)



FLS002
Hexagon 500
(575mm W x 400mm D x 490mm H)



FLS001
Hexagon 850 (Corten)
(850mm W x 700mm D)



FLS013
Extendable Outdoor Wood Storage (Base Kit)
(1220mm W x 350mm D x 1220mm H)



FLS004
Extender Outdoor Storage (1m Extension Kit)



FFT28BS
Hinterland - Fire Tool Set & Wood Storage



FFT85S
Valyrian Fire Tool Set



FFT173S
Ellipse Fire Tool Set



FFT69BE
Iron Grey Fire Tool Set

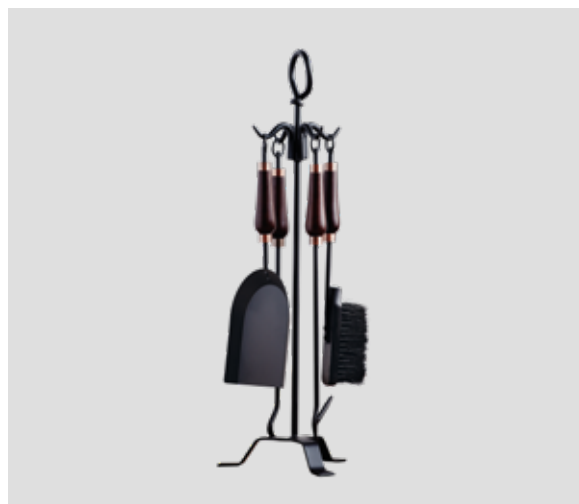

FFT104B
Mahogany Fire Tool Set

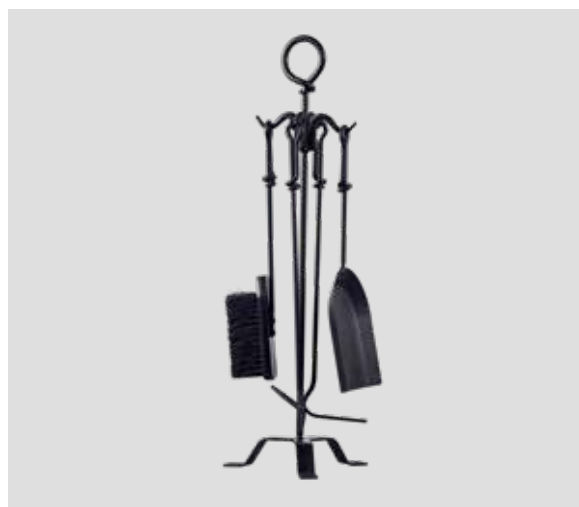

FFT175B
Heritage Fire Tool Set



SC010400043
Forge Dry Glass Cleaner (Pack size 16)



SC050600009
Forge Gloves (Pack size 12)



SC050500001
Senotherm Metallic Black High Temp Paint 400g
(Sold in Pack size 6)



SC050100002
Forge Easy Soot Flue Cleaner
(3 pack 50g / Pack size 12)



SC010400037
Forge Exo Fan - Thermal Powered (Pack size 4)



FFB304
6" Pull through flue brush - 10m rope



FFB301
6" Flue brush kit - 5m extension



SG050600008
Air-Set Fireplace Mortar 1 litre tub (Pack size 6)



SCX520
Kalora Fusion - Hot Water Jacket



SG050600007
Forge Moisture Meter (Pack size 12)



SG031000118
Forge Gasket Adhesive & Sealant 75g Tube
(Pack size 12)



FHPT105 (1050 x 1050)
FHPT105120 (1050 x 1200) - FHPT120 (1200 x 1200)
Matte black straight wall hearth



FHPT125C (1250 x 1250)
FHPT1425C (1425 x 1425)
Matte black corner wall hearth



FCCG001B
Small Safety Guard (1080w x 1055d x 800h)



FCCG003B
Large Safety Guard (1275w x 1275d x 800h)

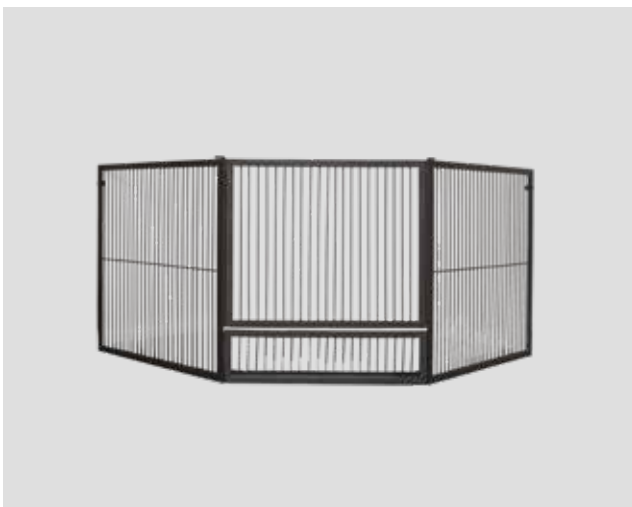

FCG001BC
Small Corner Safety Guard (1890w x 650d x 800h)

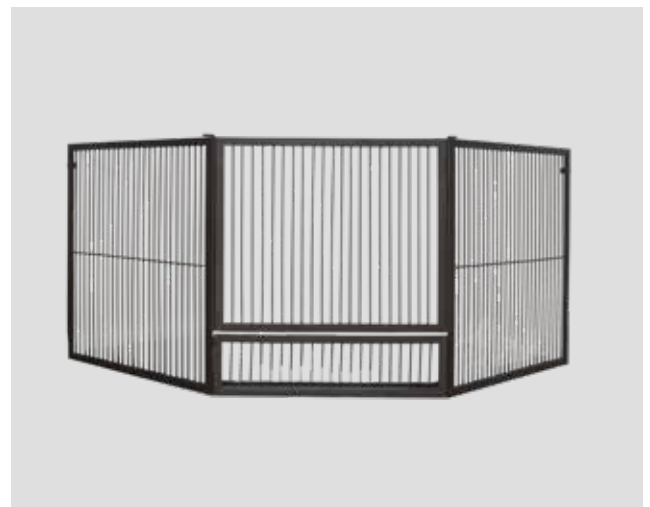

FCG003BC
Large Corner Safety Guard (2050w x 720d x 800h)



FFK64M2
Default black mesh flue kit

SG010400034
Default matte black flue kit

Includes: 2x Internal black mesh or matte black flue extensions; 1x Ceiling collar; 1x Dropbox; 1x External flue extension; 1x Anti-downdraft cowl & cone.



FF901
1mtr Internal black mesh extension

SG010400035
1mtr Internal matte black extension



FF902
1m External Triple Skin Extension Kit



SG020100011
Insulated flue kit



FF022
6" Anti-downdraft Cowl & Cone



FF012
1m 6" Stainless Steel Flue



SCF0712
Floor Penetration Box



FF015
10" Galvanised Casing



FF056
8" Black mesh 1m w/tabs and heat shield



SCF904
Internal 45 Degree Black Mesh Bend Kit Left Hand

SCF905
Internal 45 Deg Black Mesh Bend Kit Right Hand

SCF906
Internal 45 Deg Black Mesh Bend Kit Front

SG010400028
Internal 45 Degree Black Mesh Bend Kit Rear



SCF909
Internal 45 Degree Black Bend Kit Left Hand

SCF910
Internal 45 Deg Black Bend Kit Right Hand

SCF911
Internal 45 Deg Black Bend Kit Front

SG010400029
Internal 45 Degree Black Bend Kit Rear



SG010400031
External 45° Bend Kit (Triple Skin)



SCF087
Adjustable Ceiling / Wall Plate (Matte Black)



SG010400030
1 x 45 Degree Flue Bend Stainless Steel

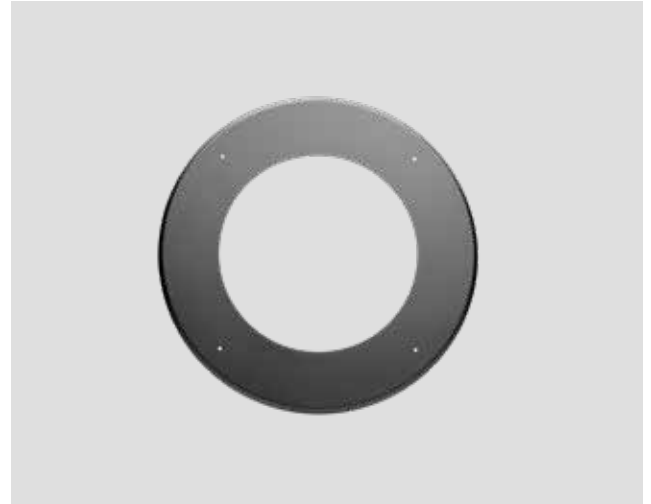

SCF094
10" Ceiling Collar (Matte Black)



SCF0171
Flexi Flue 6" (Sold by the Metre; Max 5 meters)



SCF0172
Flexi Flue 6" Adaptor



FF036
Iron Roof Flashing 171mm - 381mm (Pack size 10)



FF037
Tile Roof Flashing 10" (Pack size 5)



DV911
Direct vent gas flue 275-370mm



DV906
Direct vent gas flue 300mm



DV904
Direct vent gas flue 600mm



DV903
Direct vent gas flue 900mm



DV945G
Direct vent gas 45° elbow galvanised



DV990G
Direct vent gas 90° elbow galvanised



DV984
Direct vent gas horizontal termination



DV991
Direct vent gas high wind vertical termination

ROPE SEAL



GLASS SEAL



PART NUMBER	DESCRIPTION	Pack Size
SG030300001	Rope Seal 6mm - 2m length	12
SG030300002	Rope Seal 9mm - 2m length	12
SG030300003	Rope Seal 12mm - 2m length	12
SG030300004	Rope Seal 15 x 10mm - 2m length	12
SG030300008	Rope Seal 15mm - 2m length	12
SG030300005	Rope Seal 18mm - 2m length	12
SG030300006	Rope Seal 20mm - 2m length	12
SG030300007	Rope Seal - 25mm - 2m length	12
SG030400002	Glass Seal - 20mm - 2m length	12
SG030400001	Glass Seal - 25mm - 2m length	12

FIRE BRICK KITS



PART NUMBER	DESCRIPTION	Pack Size
SG030600025	Forge Firebricks FB09 200x145x25	10
SG030600026	Forge Firebricks FB15 250x145x25	10
SG030600027	Forge Firebricks FB16 255x160x25CH	10
SG030600031	Forge Firebricks FB19 270x185x25	5
SG030600028	Forge Firebricks FB21 285x175x25	5
SG030600029	Forge Firebricks FB41 230x115x25	10
SG030600030	Forge Firebricks FB42 230x115x38	5
FB22	Forge Firebrick 220x170x25	10
FB06	Forge Firebrick 190x178x25	10
FB64	Forge Firebrick 200x156x25	10

PROFESSIONAL INSTALLATION

It is a requirement that all Kalora solid fuel and gas appliances are fitted by a qualified, licensed installer whose work complies with local council regulations, Australian standards and manufacturer's specifications. Failure to correctly install is extremely dangerous, will void any warranty claims and may compromise any future insurance claims.

Distributed by
Kalora Pty Ltd
58 Access Way,
Carrum Downs, 3201
03 8579 5905

Orders: orders@kalora.com.au

Service Inquiries: service@kalora.com.au
kalora.com.au

Due to our policy of continuous improvement of our products and services, technical specifications and claims, correct at the time of going to print, may be subject to variation without prior notice. Kalora has endeavoured to ensure that the information in this document is correct and fairly stated, but does not accept liability for any error or omission.

Kalora Pty Ltd accepts no liability whatsoever for their interpretation of AS/NZS 2918-2001, AS/NZS 4012-4013. All heating capacities quoted are based on units tested with quality hardwood. Minimal performance reduction may result due to large glassed areas, vaulted ceilings, draughts or insufficient insulation. We reserve the right to alter specifications without

notice. The images depicted in this brochure are digitally produced for display purposes only and are not representative of the standard required to meet warranty specification. The effectiveness and performance of the overnight burning is influenced significantly by individual installation and environmental conditions and the quality of fuel used.

